

# Installation instructions Ebeco Cable Kit 200

Carefully read through the entire installation instructions before starting work.

Before you start, compare the material in your Cable Kit 200 with the table below.

Content of Ebeco Cable Kit 200									
ART.NO.	CABLE ART NO.	CABLE LENGTH	THERMOSTAT	FLEXIBLE CONDUIT	FIXING TAPE	DRUM HOLDER	SIGN	INSTALLATION INSTRUCTION	
E 89 608 50	66 608 70	13.5 m	EB-Therm 200	1 pc	2 pcs	1 pc	1 pc	1 pc	
E 89 608 51	66 608 71	18.5 m	EB-Therm 200	1 pc	2 pcs	1 pc	1 pc	1 pc	
E 89 608 52	66 608 72	23 m	EB-Therm 200	1 pc	2 pcs	1 pc	1 pc	1 pc	
E 89 608 53	66 608 73	31 m	EB-Therm 200	1 pc	2 pcs	1 pc	1 pc	1 pc	
E 89 608 54	66 608 74	37 m	EB-Therm 200	1 pc	2 pcs	1 pc	1 pc	1 pc	
E 89 608 55	66 608 75	43 m	EB-Therm 200	1 pc	2 pcs	1 pc	1 pc	1 pc	
E 89 608 56	66 608 76	49 m	EB-Therm 200	1 pc	2 pcs	1 pc	1 pc	1 pc	
E 89 608 57	66 608 77	58 m	EB-Therm 200	1 pc	2 pcs	1 pc	1 pc	1 pc	
E 89 608 58	66 608 78	73 m	EB-Therm 200	1 pc	3 pcs	1 pc	1 pc	1 pc	
E 89 608 59	66 608 79	86 m	EB-Therm 200	1 pc	3 pcs	1 pc	1 pc	1 pc	
E 89 608 60	66 608 80	107 m	EB-Therm 200	1 pc	4 pcs	1 pc	1 pc	1 pc	
E 89 608 61	66 608 81	124 m	EB-Therm 200	1 pc	4 pcs	1 pc	1 pc	1 pc	
E 89 608 62	66 608 82	155 m	EB-Therm 200	1 pc	5 pcs	1 pc	1 pc	1 pc	
E 89 608 63	66 608 83	187 m	EB-Therm 200	1 pc	6 pcs	1 pc	1 pc	1 pc	
COMPLEMENTARY KIT FOR LARGER AREAS WITHOUT THERMOSTAT									
E 89 608 90	66 608 80	107 m		1 pc	4 pcs		1 pc	1 pc	

## General instructions

Cable Kit 200 is a complete underfloor heating system consisting of a thin heating cable, fixing tape, EB-Therm 200 thermostat and flexible conduit. A hand drum holder is also supplied, for quick, simple installation. The system is primarily intended to heat tiled and natural stone floors, but can also be installed under wood, laminate and vinyl floorcovering. The diameter of the cable is only 4 mm. The system is connected at one end and the electrical and electromagnetic fields are negligible. The system must be laid in a layer of screed, minimum thickness 5 mm, on existing flooring such as concrete, chip- or plasterboard. The system can also be laid in wooden joist floors. Begin by reading the relevant parts of the general instructions on this page, then go to the instructions for laying the system in wooden joist floors. Detailed instructions for this can be found at the end of the installation instructions.

- Check the length of the cable is correct and that the article number agrees with the table above.
- The maximum output is 120 W/m<sup>2</sup>. This means a centre spacing of about 9 cm.
- The Cable Kit can also be installed under wooden and laminate floors and under vinyl floorcoverings. Here, the output should not be higher than 75 W/m<sup>2</sup> (centre spacing about 15 cm).
- For uniform heat distribution, the thickness of the self-levelling screed should be:  
Wooden floor: at least 8 mm. Laminate: at least 10 mm. Vinyl floorcovering at least 15 mm.
- The installation must be controlled by one of Ebeco's EB-Therm thermostats.
- The system must be connected to 230 V via a 30 mA earth fault relay.
- **The heating cable must not be cut or crossed. Only the cold cable may be cut.**
- Plan the layout so that the cold cable splice and the end termination do not end up in the shower area.
- The lowest temperature when fixing with adhesive tape is +18°C. The adhesive properties of the tape are reduced when the temperature of the floor is lower. Screed must be applied as soon as possible after laying the cable. If there is a delay before it is applied, press down the tape once more before applying the screed.
- The heating cable must not be laid under fixed fittings such as kitchen units, wardrobes, internal walls, etc., since this leads to overheating.
- Measure the insulation and resistance of the cable before and after laying, and after laying the floor. Enter the values in the test report in the guarantee certificate supplied. The ten-year guarantee is not valid without the signature of an authorised electrician.
- **Wait 4 weeks before switching on the heating, then increase the level of heating gradually.**
- Where the underfloor heating system is installed over a concrete floor laid directly on the ground, the heating should not be completely switched off during the summer.
- Do not cover the finished floor with thick, insulating carpets, "bean bags" etc., since this may cause local overheating and damage the floor.
- Affix the sign supplied at the electricity distribution board ("consumer unit"). At the same location there must also be a sketch of the cable layout; see the guarantee certificate.

**The underfloor heating system is a mains voltage installation and must therefore be installed and connected in accordance with the current national regulations.**

**Resistance value Ebeco Cable Kit 200**

Tolerances ± 10 %

ART NO.	POWER	LENGTH	AREA AT C-C APPROX.		AREA AT C-C APPROX.	RESISTANCE
			9 CM AND 120 W/M <sup>2</sup>	11 CM AND 100 W/M <sup>2</sup>		
E 89 608 50	150 W	13.5 m	1.3 m <sup>2</sup>	1.5 m <sup>2</sup>	2.0 m <sup>2</sup>	350 ohm
E 89 608 51	200 W	18.5 m	1.7 m <sup>2</sup>	2.0 m <sup>2</sup>	2.7 m <sup>2</sup>	260 ohm
E 89 608 52	260 W	23 m	2.1 m <sup>2</sup>	2.6 m <sup>2</sup>	3.4 m <sup>2</sup>	207 ohm
E 89 608 53	330 W	31 m	2.7 m <sup>2</sup>	3.3 m <sup>2</sup>	4.4 m <sup>2</sup>	161 ohm
E 89 608 54	400 W	37 m	3.3 m <sup>2</sup>	4.0 m <sup>2</sup>	5.3 m <sup>2</sup>	133 ohm
E 89 608 55	470 W	43 m	3.9 m <sup>2</sup>	4.7 m <sup>2</sup>	6.3 m <sup>2</sup>	112 ohm
E 89 608 56	540 W	49 m	4.5 m <sup>2</sup>	5.4 m <sup>2</sup>	7.2 m <sup>2</sup>	98 ohm
E 89 608 57	650 W	58 m	5.4 m <sup>2</sup>	6.5 m <sup>2</sup>	8.7 m <sup>2</sup>	81 ohm
E 89 608 58	810 W	73 m	6.7 m <sup>2</sup>	8.1 m <sup>2</sup>	10.7 m <sup>2</sup>	66 ohm
E 89 608 59	960 W	86 m	8.0 m <sup>2</sup>	9.6 m <sup>2</sup>	12.8 m <sup>2</sup>	55 ohm
E 89 608 60	1180 W	107 m	9.8 m <sup>2</sup>	11.8 m <sup>2</sup>	15.7 m <sup>2</sup>	45 ohm
E 89 608 61	1380 W	124 m	11.5 m <sup>2</sup>	13.8 m <sup>2</sup>	18.3 m <sup>2</sup>	38 ohm
E 89 608 62	1710 W	155 m	14.2 m <sup>2</sup>	17.1 m <sup>2</sup>	22.7 m <sup>2</sup>	31 ohm
E 89 608 63	2080 W	187 m	17.3 m <sup>2</sup>	20.8 m <sup>2</sup>	27.7 m <sup>2</sup>	25 ohm

COMPLEMENTARY KIT FOR LARGER AREAS WITHOUT THERMOSTAT

E 89 608 90	1180 W	107 m	9.8 m <sup>2</sup>	11.8 m <sup>2</sup>	15.7 m <sup>2</sup>	45 Ohm
-------------	--------	-------	--------------------	---------------------	---------------------	--------

\* Requires a layer of screed at least 10 mm thick for good heat distribution.

Configuration 1 is used when the heating system is laid on concrete, plaster- or chipboard

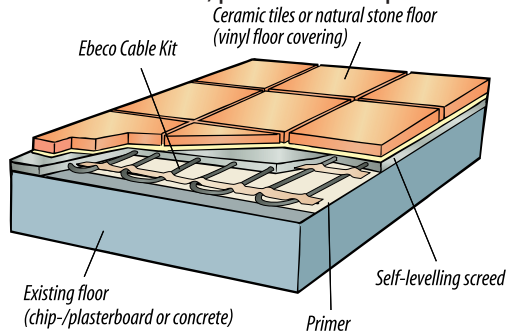

Configuration 2 is used when the heating system is laid in a wooden joist floor

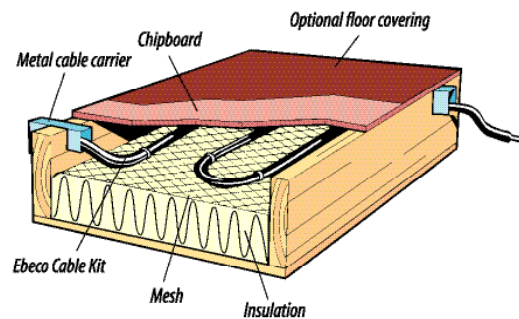

In addition to the Ebeco Cable Kit you will need:

- Self-levelling screed (Uniplan E 89 605 43)
- Primer (E 89 605 49)
- Earth fault relay, if not already installed in the building (E 21 643 06)

The following are needed when the heating system is laid in a wooden joist floor:

- Metal cable carrier (E 89 603 90)
- Plaster net, (E 89 603 92 or E 89 603 94)
- Earth fault relay, if not already installed in the building (E 21 643 06)

**Substrate**

Make sure that the floor is firm, does not sag and is free from dirt and old floorcovering material. Wood and chip-board floors over joists spaced at more than 30 cm need to be strengthened to prevent cracks from forming and tiles from coming loose. This applies even without underfloor heating.

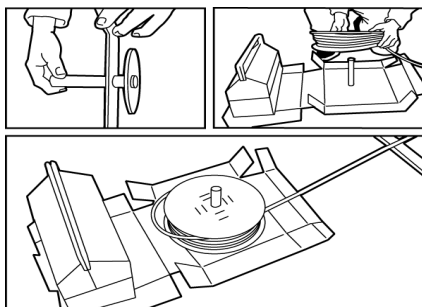

Figure 1-3

**Drumholder**

To make it easier to lay the cable, a plastic drumholder is supplied in the pack. Place the drumholder in the perforated hole under the bottom of the pack. Lift the drum on to the drum holder and place a heavy object on the lid of the pack. When you pull on the cable, the drum rotates (Figures 1-3).

**Installing**

Chase a groove in the floor for the flexible conduit, where the floor sensor of the thermostat will be located. Place the floor sensor between two loops of the cable (Figure 4). Position the exposed end of the flexible conduit 30-60 cm into the room, where it will not be covered by carpets or furnishing. If the bend in the flexible conduit is too sharp it will be difficult to install the sensor. Be sure to make a smooth bend. Carefully seal the end of the flexible conduit with adhesive tape (Figure 4). The tube at the side of the flexible conduit is intended for the cold cable.

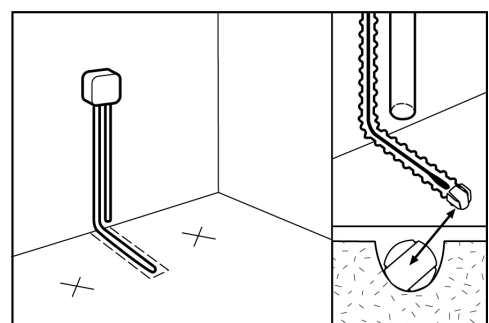

Figure 4

The cold cable splice must be in the floor. Make a recess in the floor so that the height of the splice is not greater than the thickness of the layer of screed.

Prime the floor surface with Ebeco Primer (E 89 605 49) and let it dry (Figure 5).

Measure the insulation and resistance of the cable and enter the readings in the test report.

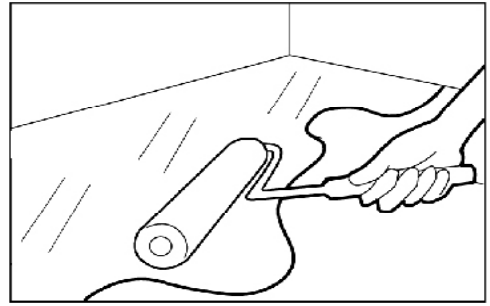

Figure 5

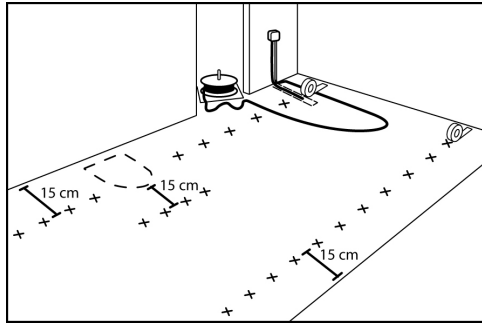

Figure 6

Calculate the distance between centres using the formula below. Mark the c/c measurements on the floor about 15 cm from each wall. Secure the tape reels, one on each side of the floor, at the first mark (Figure 6).

Note: Take care when calculating and marking so that the cable fits exactly into the space.

$$c/c\text{-distance} = \frac{\text{laying area}}{\text{cable length}}$$

Using tape halves the installation time and makes it easier to adjust the cable during the entire installation procedure. Pull out the first loop of the cable and fix it with tape about 15 cm from the bend (Figure 7). Leave the tape reels in place. Don't remove the protective paper on the upperside of the adhesive tape. The distance between the cable and the wall should be approx. half the c/c-distance.

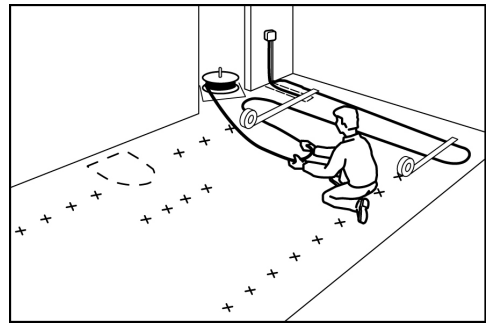

Figure 7

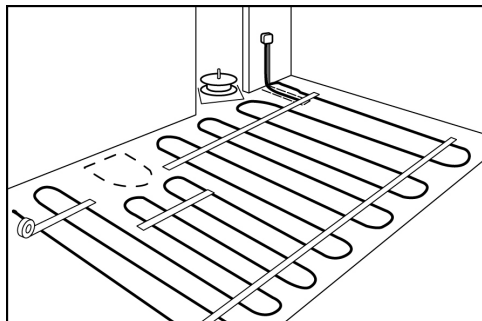

Figure 8

Do the same with the next loop. Do not lay the cable under fixed equipment, WC pans, etc. Note the position of the WC pan fixing screws (Figure 8).

At floor drains or similar obstructions, lay the cable as shown in Figure 9. Do not lay the cable too close to the floor gully. Leave space for the floor gully grating.

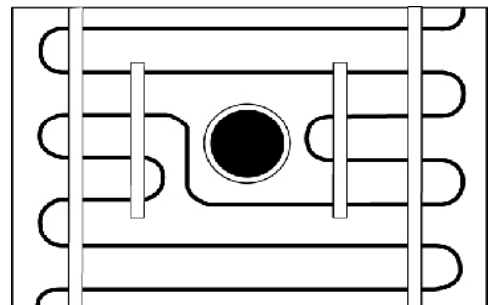

Figure 9

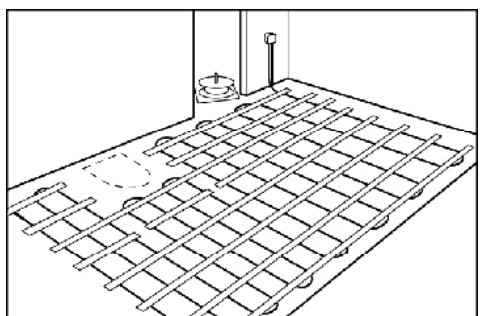

Figure 10

When the entire cable has been laid, apply new strips of tape on either side of the first strip, at a distance of about 17 cm (Figures 10 and 11).

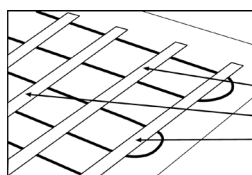

Figure 11

The first strip of tape.  
Apply tape on either side of the first strip. Apply tape 2 cm from the cable bend.

To make sure that the tape sticks properly, it can be pressed down with hands or feet. This is especially important on rough surface, such as concrete. To protect the cable, wear soft-soled shoes or go barefoot. If you do not apply the screed immediately after taping the cable, you **have to** press the tape down once more just before applying the screed (Figures 12 and 13).

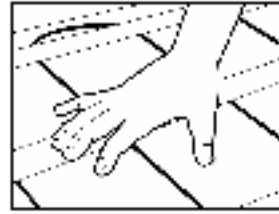

Figure 12



Figure 13

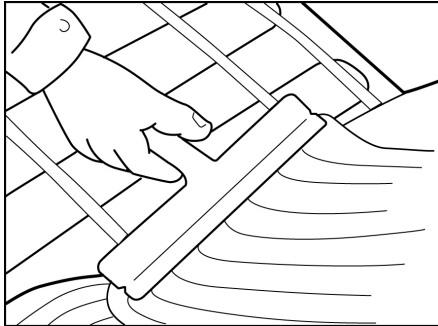

Figure 14

Measure the insulation and resistance of the cable again and enter the readings in the test report. Record the position of the cable with a sketch or photo and keep it by the electricity distribution board. Apply self-levelling screed to the floor (Figure 14).

Measure the insulation and resistance of the cable again, to check that the cable was not damaged when the screed was applied. Lay the floor tiles in accordance with the manufacturer's instructions. Use flexible tile adhesive and grout (Figure 15).

Measure the insulation and resistance of the cable once more and enter the readings in the test report. For floor design, filling, sealing layer, tiling, grouting, etc., see the current trade rules and the supplier's instructions.

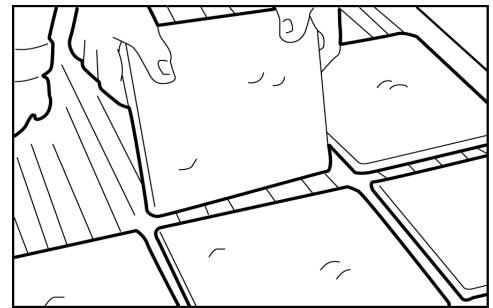

Figure 15

## Laying in wooden joist floors

Lay a mesh over the insulation to form air gap of about 3 cm. Secure the mesh to the floor joists with a staple gun or similar tool. Measure the insulation and resistance of the cable before laying and enter the readings in the test report.

For simpler laying, read "Drumholder" after "General instructions".

Unreel the cable, starting at the connection box. Do not lay more than 4 loops per bay ( $c/c = 14$  cm). The cable join must be fixed to the mesh. The fixing points must not be more than 35 cm apart. Lay the heating cable so that it crosses the joists at a wall. Cut out the joist and insert a metal cable carrier (E 89 603 90). The distance between the cable and the joists must be at least 2 cm. The cable must not touch or cross itself. Minimum distance 5 cm.

**NOTE: Maximum permitted output 80 W/m<sup>2</sup>.** With 4 loops per 60 cm bay, the output is about 75 W/m<sup>2</sup>. With 3 loops per 60 cm bay, the output is about 55 W/m<sup>2</sup>.

After the cable has been laid, its insulation and resistance must be measured again, to make sure that the cable was not damaged during laying. Enter the values in the test report. Check also that the cable is not covered with insulation or other building debris.

The room temperature is controlled with one of Ebeco's EB-Therm thermostats. The floor sensor for the thermostat is installed in a length of flexible conduit which is placed directly under the floor sheet next to a floor joist. Carefully seal the end of the flexible conduit with tape.

Lay the chipboard sheets. The floor finish is laid directly on these. Wooden floors must not be laid directly on the joists/air gap, because of the risk of uneven drying. After laying the floor, measure the insulation and resistance of the cable and enter the readings in the test report.